

GRAF Rainwater Flat tank
Platin 7500 L

Order no.

390005

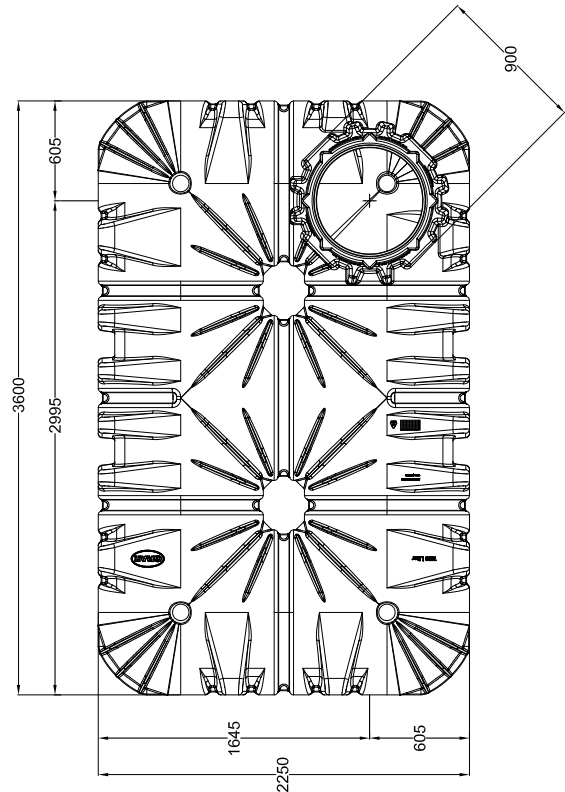
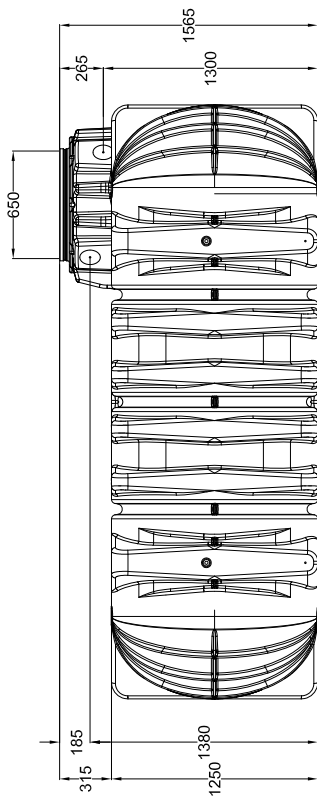
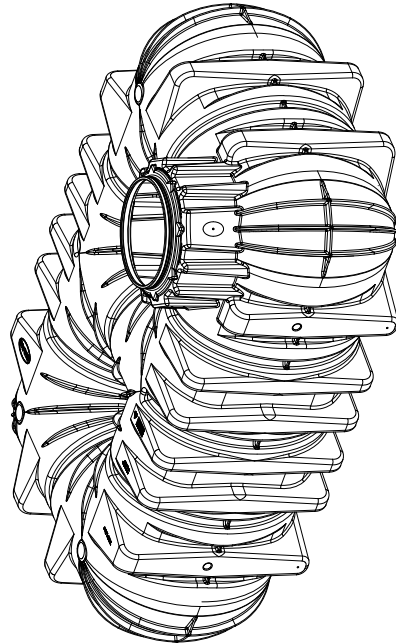
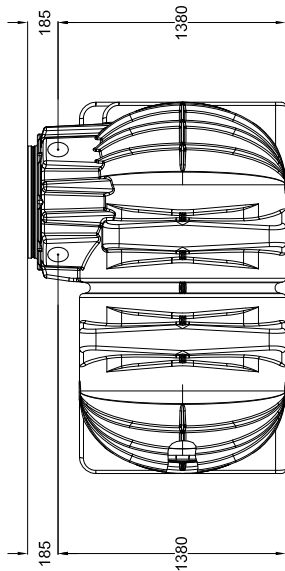

www.graf.info
info@graf.info

All Dimensions in mm
+/- 3 % Tolerance

Weight

Approx. 360 kg

Date

04.01.2011

Name

Sheet 1/1