

1

2

3

4

A

B

C

D

E

F

H
2500
3000
3500
4000

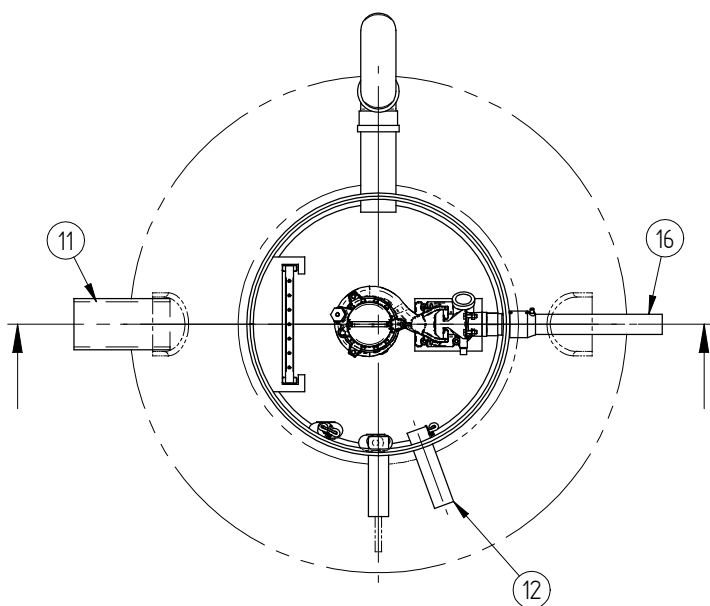
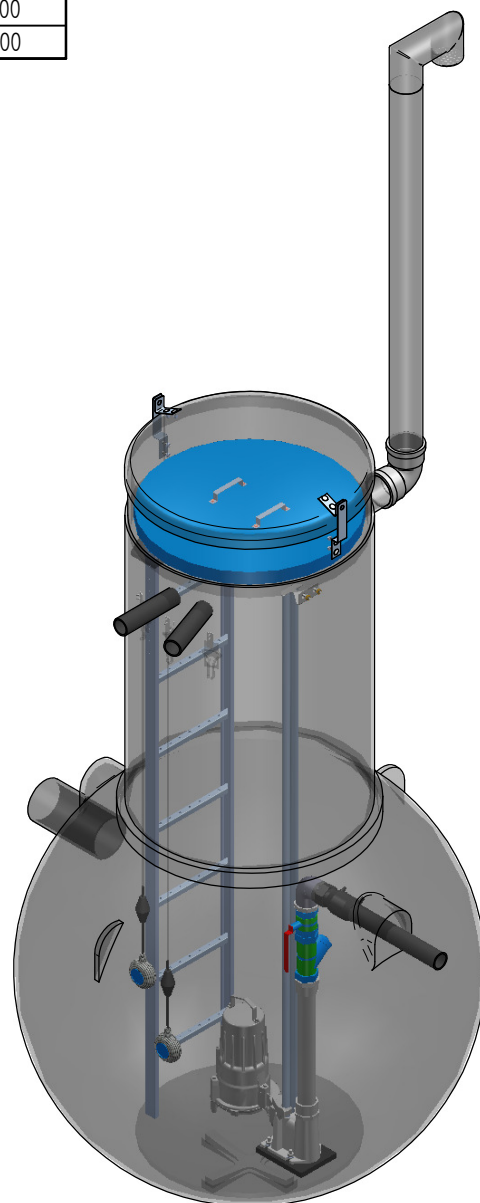
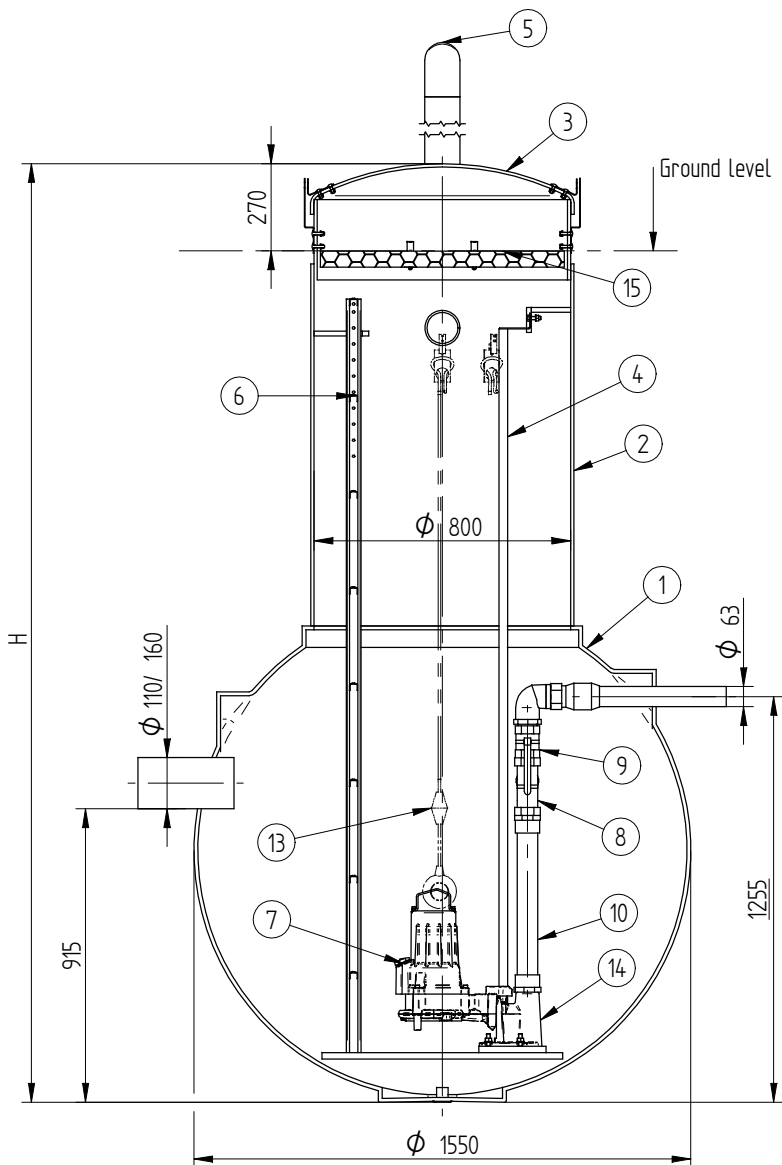

Pos.	Name	Technical data	Quantity
1	Well	PE, Ø1550	1
2	Manhole	PE, Ø800	1
3	Cover, lockable	PE	1
4	Guide rail	AISI304	2
5	Ventilation	PE, Ø110	1
6	Ladder	AISI316	1
7	Pump		1
8	Check valve	GGG, DN50	1
9	Ball valve	DN50	1
10	Discharge pipe	DN50	1
11	Inlet pipe	PE, Ø160	1
12	Cable pipe	PE, Ø63	2
13	Switch key		2
14	Pump pedestal	GGG, DN50	1
15	Insulating cover	Styrofoam	1
16	Outlet pipe	PE, Ø63	1

01.02.2016

Date

Enjin.

Signature

Sheets

Pumpingstation "Ester"

Name

eccua



Mass

Number

Rv

All rights reserved.