

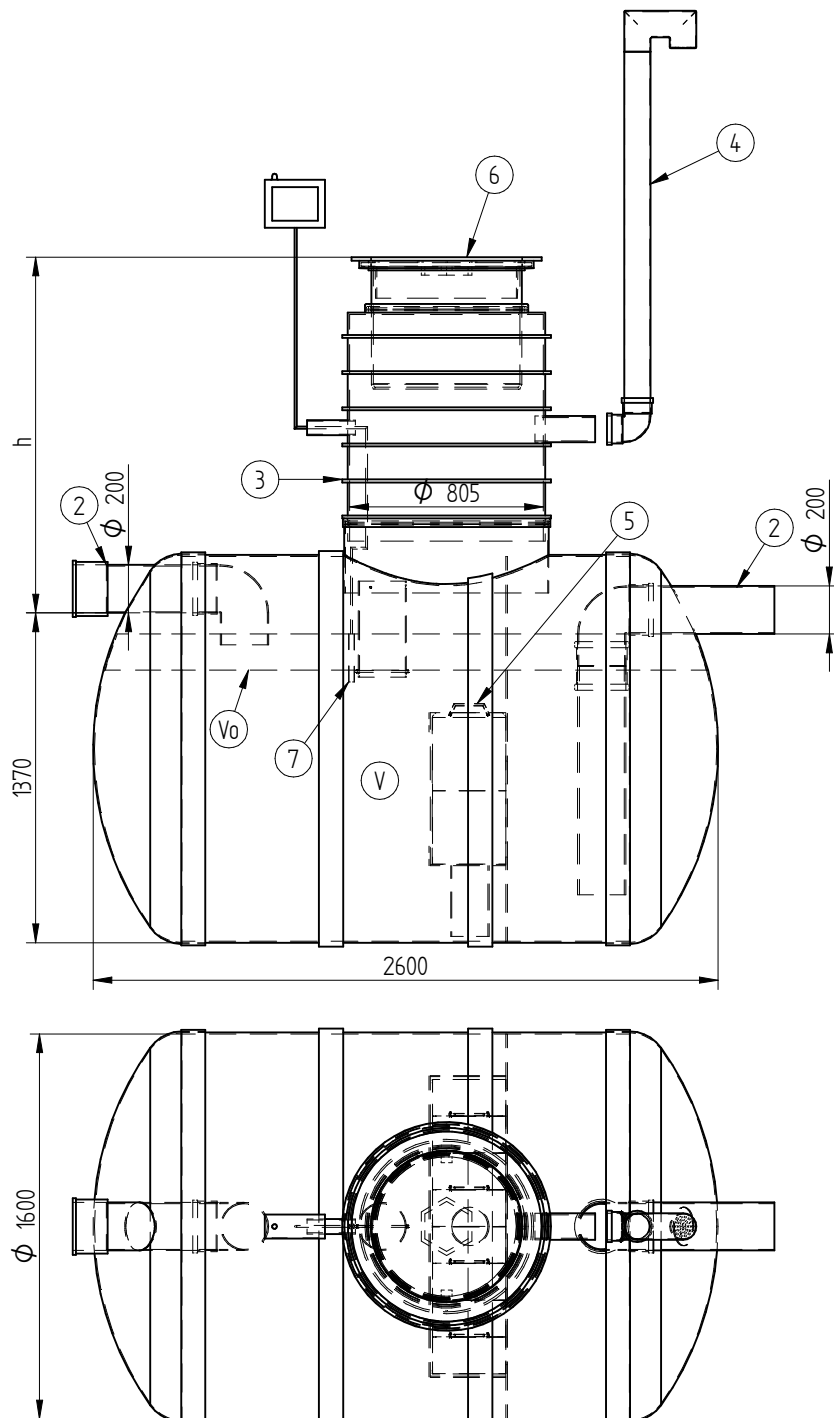

EN 858-1

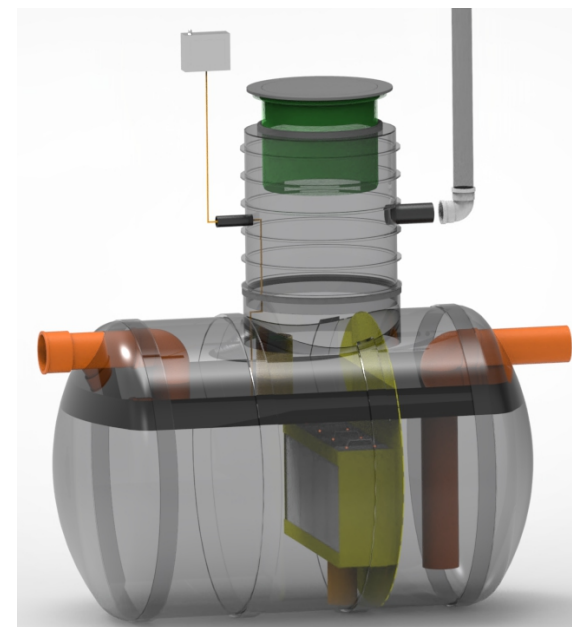

I'd like to order

I'd like a quote

Mark the installation depth of the tank h (depth from the ground to the bottom of the inlet pipe in mm)

h =

Notes (name of project or address, special need etc):

No	NAME	MATERIAL	SIZE	Qn/pcs
1	Separators body	GRP	D1600,H2600	1
2	Inlet- outlet pipe	PE-HD	D200mm	1
3	Inspectionwell (choose the right depth)	PE-HD	D800 mm	1
	Installation depth h is measured from inlet pipe bottom to groundlevel in mm. On special occasions we can adapt the body for deeper installation)			
4	Ventilationpipe	PE	D110 mm	1
5	Oil coalescence unit HD Q-PAC			1
V	Whole volume		3535 dm3	
Vo	Oil layer volume		470 dm3	
ADDITIONAL EQUIPEMENT (Make Your choice)				
6	Telescopic cover D600 mm			
7	Oilseparator alarmunit			
8	Automatic closing valve			

Please send the completed form by e-mail

Please check your selections and measurements before sending

Date	Engin	Signature	Sheets	OILSEPARATOR I class EQ NS15	
eccua		Mass	Number	RV	