

SECTION A-A

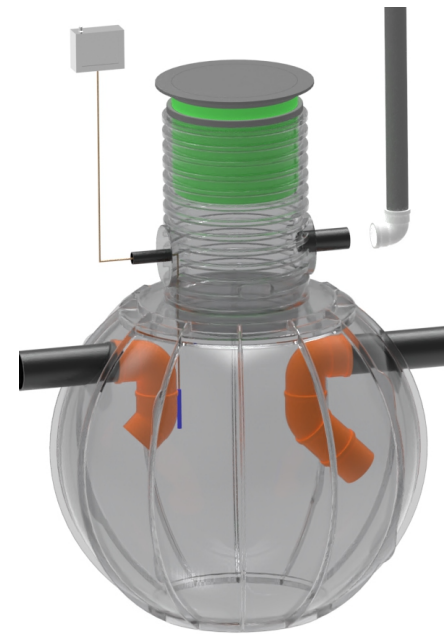
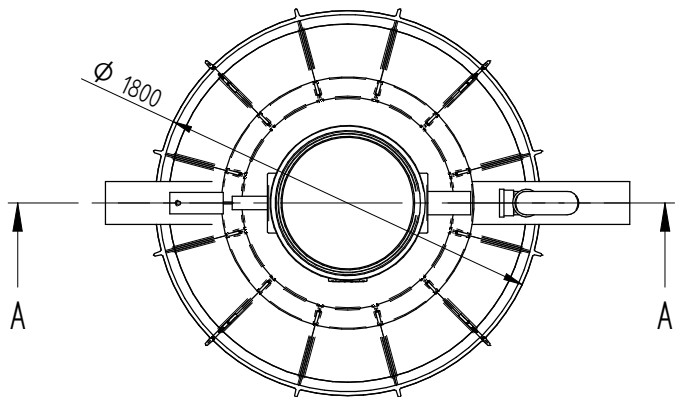

I'd like to order

I'd like a quote

Mark the installation depth of the tank h (depth from the ground to the bottom of the inlet pipe in mm)
h=

Notes (name of project or address, special need etc):

NR	NAME	MATERIAL	SIZE	Qn/pcs
1	Separators body	PE-HD	D1800	1
2	Inlet- outlet pipe	PE-HD	D200mm	1
3	Inspectionwell (choose the right depth)	PE-HD	D600 mm	1
	Installation depth h is measured from inlet pipe bottom to groundlevel in mm. On special occasions we can adapt the body for deeper installation)			
4	Ventilationpipe	PE	D110 mm	1
	V	Whole volume		
		2330 dm3		
	Vo	Oil layer volume		
		350 dm3		
	Vm	Sand-mud volume		
		1500 dm3		
ADDITIONAL EQUIPEMENT (Make Your choice)				
5	Telescopic cover			
6	Oilseparator alarmunit (Make Your choice)			

7

Please send the completed form by e-mail

Please check your selections and measurements before sending

Date	Engin	Signature	Sheets	OILSEPARATOR II class NS15	
eccua		Mass	Number	RV	